

## TO-92L Plastic-Encapsulate Transistors

### 2SD667, 2SD667A TRANSISTOR (NPN)

#### FEATURES

- Low Frequency Power Amplifier
- Complementary Pair with 2SB647/A

#### MARKING

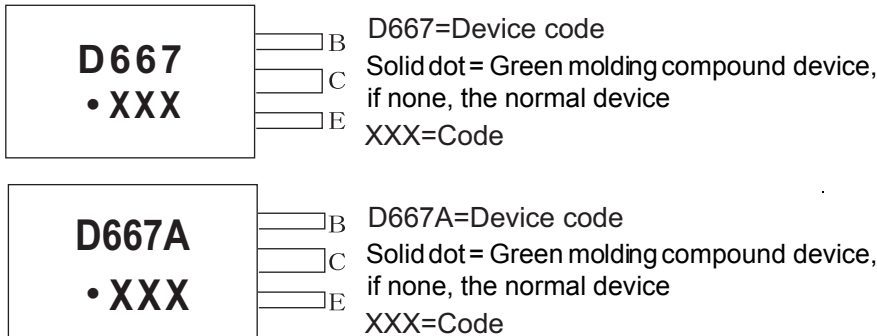
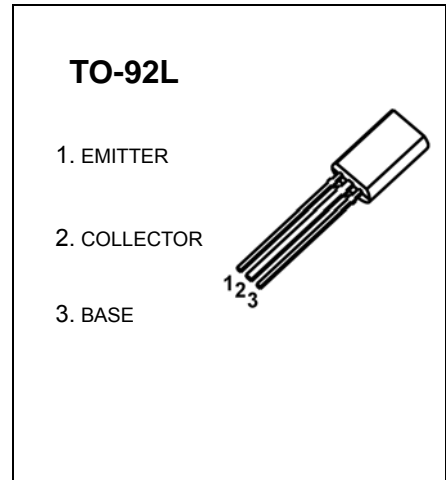

#### Equivalent Circuit

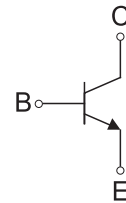

#### ORDERING INFORMATION

Part Number	Package	Packing Method	Pack Quantity
2SD667	TO-92L	Bulk	500pcs/Bag
2SD667-TA	TO-92L	Tape	2000pcs/Box
2SD667A	TO-92L	Bulk	500pcs/Bag
2SD667A-TA	TO-92L	Tape	2000pcs/Box

#### MAXIMUM RATINGS (T<sub>a</sub>=25°C unless otherwise noted)

Symbol	Parameter	Value	Unit
V <sub>CB0</sub>	Collector- Base Voltage	120	V
V <sub>CEO</sub>	Collector-Emitter Voltage	2SD667	80
		2SD667A	100
V <sub>EBO</sub>	Emitter-Base Voltage	5	V
I <sub>c</sub>	Collector Current -Continuous	1	A
P <sub>c</sub>	Collector Power Dissipation	900	mW
R <sub>θJA</sub>	Thermal Resistance Junction to Ambient	139	°C/W
T <sub>J</sub>	Junction Temperature	150	°C
T <sub>stg</sub>	Storage Temperature	-55-150	°C

## ELECTRICAL CHARACTERISTICS

$T_a=25^\circ\text{C}$  unless otherwise specified

Parameter	Symbol	Test conditions	Min	Typ	Max	Unit
Collector-base breakdown voltage	$V_{(BR)CBO}$	$I_C=10\mu\text{A}, I_E=0$	120			V
Collector-emitter breakdown voltage	$V_{(BR)CEO}$	$I_C=1\text{mA}, I_B=0$	2SD667	80		V
			2SD667A	100		V
Emitter-base breakdown voltage	$V_{(BR)EBO}$	$I_E=10\mu\text{A}, I_C=0$	5			V
Collector cut-off current	$I_{CBO}$	$V_{CB}=100\text{V}, I_E=0$			10	$\mu\text{A}$
Emitter cut-off current	$I_{EBO}$	$V_{EB}=4\text{V}, I_C=0$			10	$\mu\text{A}$
DC current gain	$h_{FE(1)}$	$V_{CE}=5\text{V}, I_C=150\text{mA}$	2SD667	60		320
			2SD667A	60		320
	$h_{FE(2)}$	$V_{CE}=5\text{V}, I_C=500\text{mA}$	30			
Collector-emitter saturation voltage	$V_{CE(sat)}$	$I_C=500\text{mA}, I_B=50\text{mA}$			1	V
Base-emitter voltage	$V_{BE}$	$V_{CE}=5\text{V}, I_C=150\text{mA}$			1.5	V
Transition frequency	$f_T$	$V_{CE}=5\text{V}, I_C=150\text{mA}$		140		MHz
Collector output capacitance	$C_{ob}$	$V_{CB}=10\text{V}, I_E=0, f=1\text{MHz}$		12		pF

### CLASSIFICATION OF $h_{FE(1)}$

Rank		B	C	D
Range	2SD667	60-120	100-200	160-320
	2SD667A	60-120	100-200	160-320

# Typical Characteristics

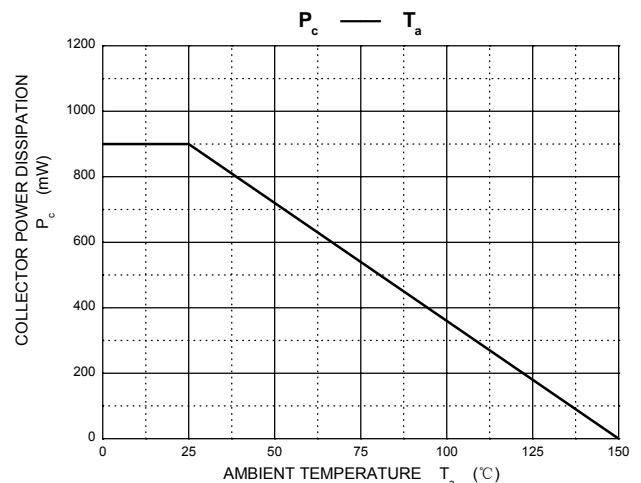
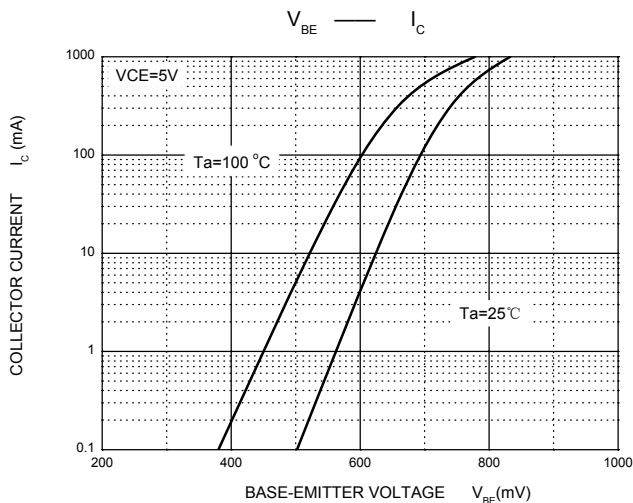
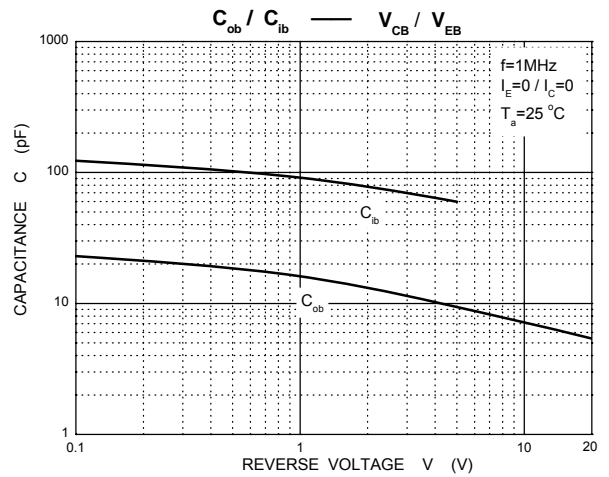
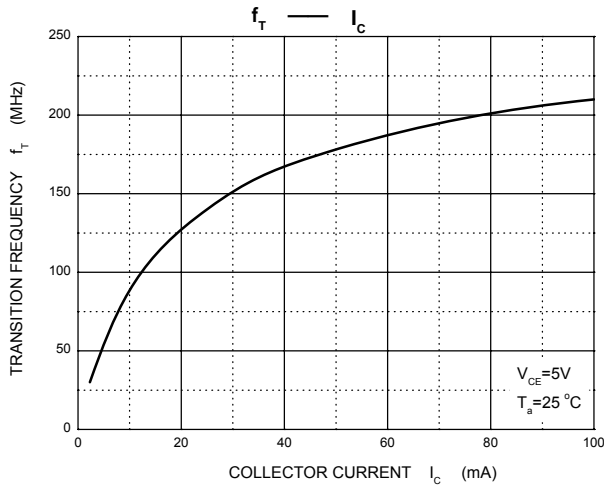
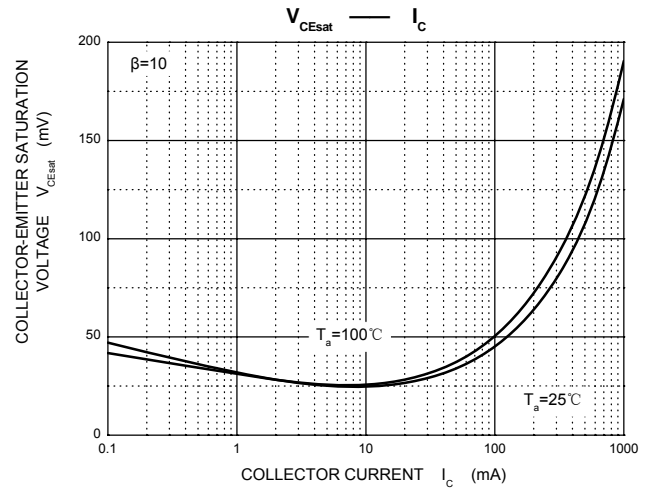
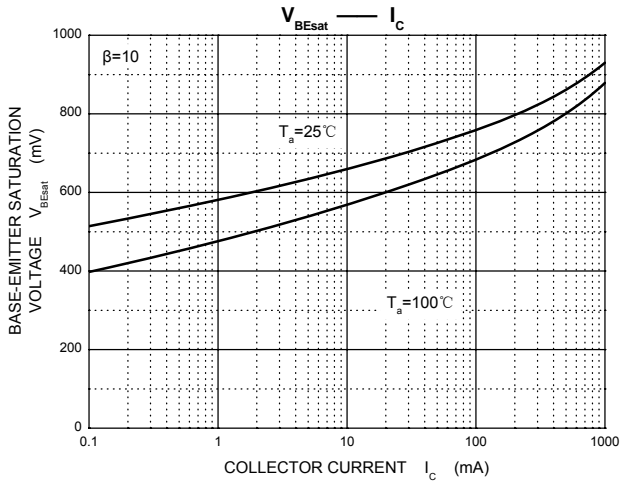
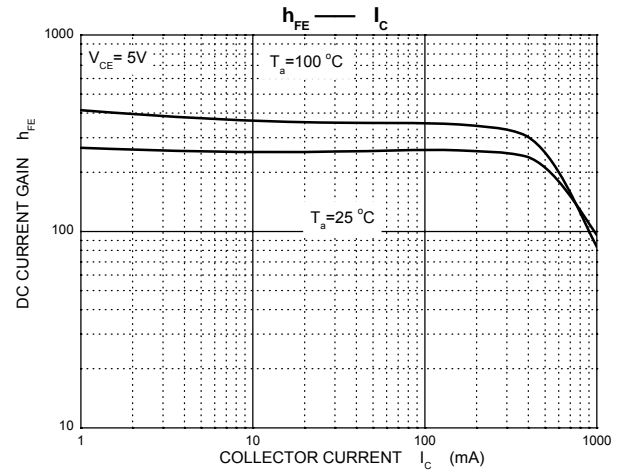
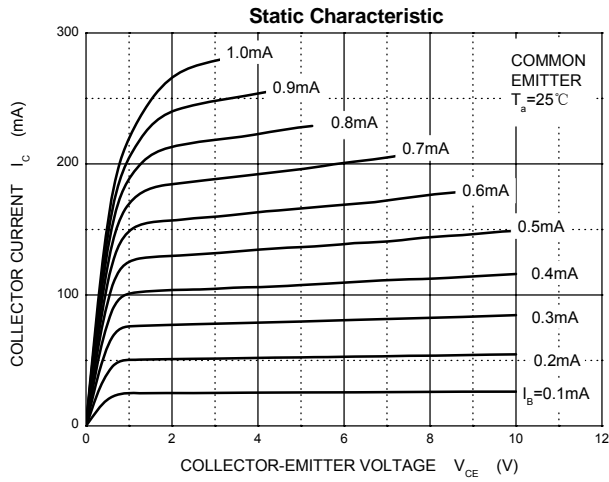

## TO-92L Package Outline Dimensions

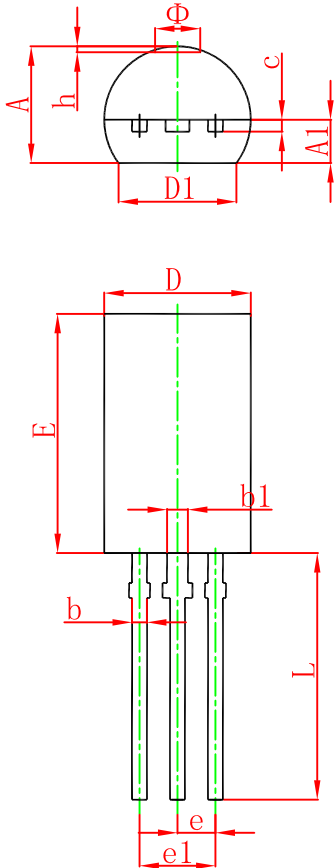

Symbol	Dimensions In Millimeters		Dimensions In Inches	
	Min.	Max.	Min.	Max.
A	3.750	4.050	0.148	0.159
A1	1.280	1.580	0.050	0.062
b	0.380	0.550	0.015	0.022
b1	0.620	0.780	0.024	0.031
c	0.350	0.450	0.014	0.018
D	4.750	5.050	0.187	0.199
D1	4.000		0.157	
E	7.850	8.150	0.309	0.321
e	1.270 TYP.		0.050 TYP.	
e1	2.440	2.640	0.096	0.104
L	13.800	14.200	0.543	0.559
$\Phi$		1.600		0.063
h	0.000	0.300	0.000	0.012

## TO-92L Suggested Pad Layout

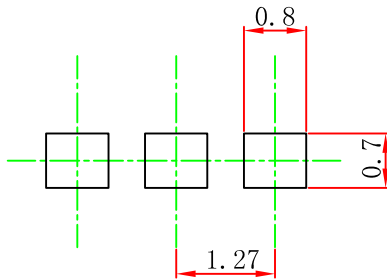

### Note:

1. Controlling dimension: in millimeters.
2. General tolerance:  $\pm 0.05$  mm.
3. The pad layout is for reference purposes only.

### NOTICE

JCET reserve the right to make modifications, enhancements, improvements, corrections or other changes without further notice to any product herein. JCET does not assume any liability arising out of the application or use of any product described herein.

# TO-92L PACKAGE TAPEING DIMENSION

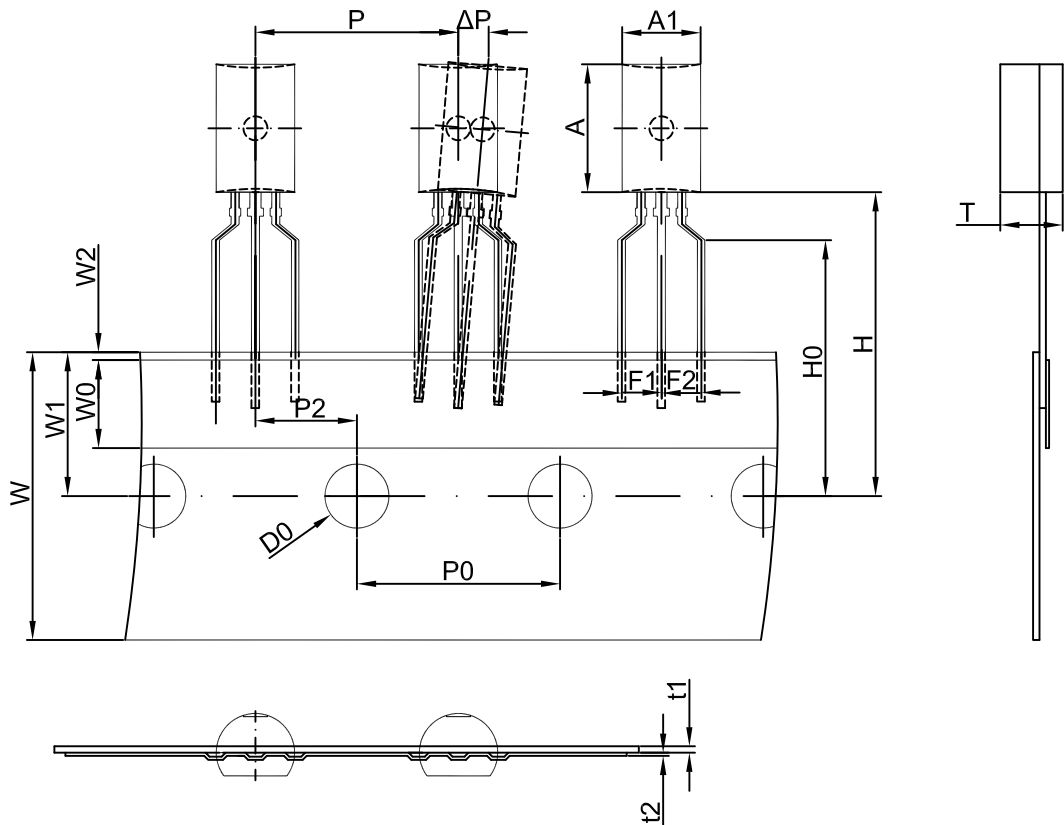

Dimensions are in millimeter

A1	A	T	P	P0	P2	F1	F2	W
4.9	8.0	3.9	12.7	12.7	6.35	2.5	2.5	18.0
W0	W1	W2	H	H0	D0	t1	t2	ΔP
6.0	9.0	1.0	19.0	16.0	4.0	0.4	0.2	0

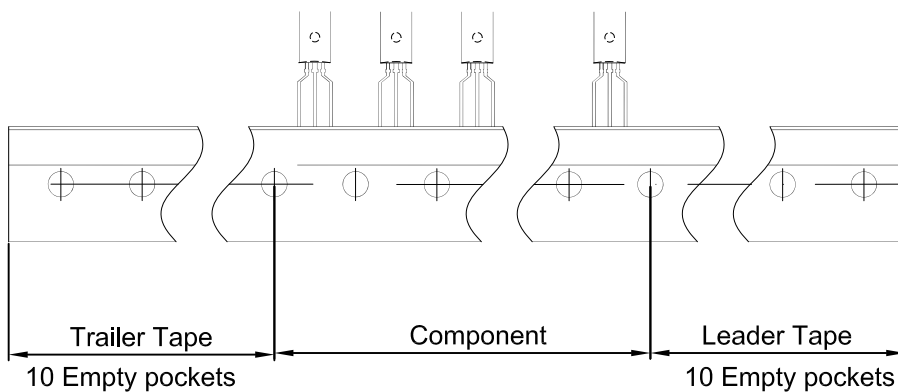

Package	Box	Box Size(mm)	Carton	Carton Size(mm)
TO-92L	2000 pcs	333×203×42	20,000 pcs	493×400×264